

SIGN	DESCRIPTION	DATE	APPROVER

PCB. LAYOUT

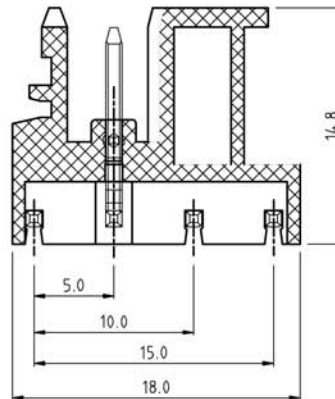
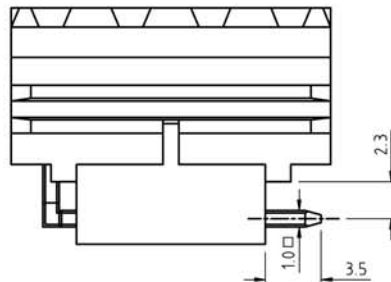
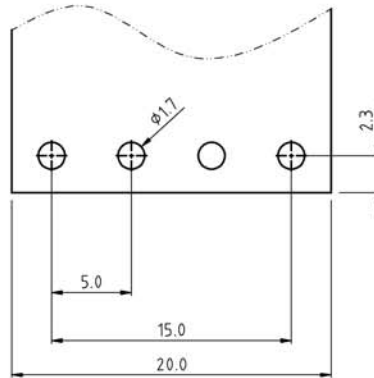
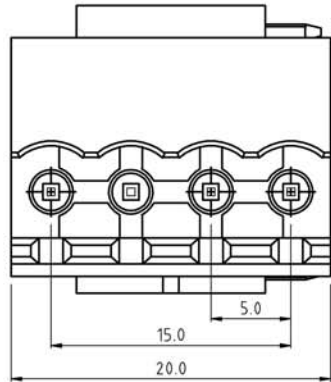

Technical Data:

Material:

Solder Pin: Copper Alloy, Tin plated
 Insulator body(housing): Polyamide
 (Glass filled)(UL94V-0)

Electrical

Voltage rating: 300VAC
 Current rating: 16A
 Withstanding Voltage: AC 2500V(1min)

Mechanical:

Using temperature Range: -40°C to +105°C
 Soldering temperature:+250°C,5seconds Max.

Ordering Information:

F85-9-5 XX-0 0 1 X 0

02 - 4Pin

- 5 Green
- 6 Blue
- A Black
- 0 left
- 1 right

WELINK 上海拓尔普电子科技有限公司
 Welink International Co.,LTD.

TOLERANCE	APPROVED:	NAME:
X ±0.30	CHECKED:	F85-9 Pitch 5.0mm
X.X ±0.15	DRAWN: YangMing 2012,06,30	-04Pole right
X.XX ±0.05	UNITS: mm	REV: A
X° ±1°	SCALE: 3 / 1	PAGE: 1 / 1
		PART NO: F859504001X0
		DWG NO: 9F8595003A